

STABILITY AND SENSITIVITY ANALYSIS OF THE EPIDEMIOLOGICAL MODEL BE-CODIS PREDICTING THE SPREAD OF HUMAN DISEASES BETWEEN COUNTRIES

BENJAMIN IVORRA, DIÈNE NGOM, ANGEL M. RAMOS

Communicated by Jesus Ildefonso Diaz

ABSTRACT. The Ebola virus disease is a lethal human and primate disease that requires a particular attention from the international health authorities due to important recent outbreaks in some Western African countries and isolated cases in Europe and North-America. Regarding the emergency of this situation, various decision tools, such as mathematical models, were developed to assist the authorities to focus their efforts in important factors to eradicate Ebola. In a previous work, we proposed an original deterministic spatial-temporal model, called Be-CoDiS (Between-Countries Disease Spread), to study the evolution of human diseases within and between countries by taking into consideration the movement of people between geographical areas. This model was validated by considering numerical experiments regarding the 2014-16 West African Ebola Virus Disease epidemic. In this article, we perform a stability analysis of Be-CoDiS. Our first objective is to study the equilibrium states of simplified versions of this model, limited to the cases of one or two countries, and determine their basic reproduction ratios. Then, we perform a sensitivity analysis of those basic reproduction ratios regarding the model parameters. Finally, we validate the results by considering numerical experiments based on data from the 2014-16 West African Ebola Virus Disease epidemic.

1. INTRODUCTION

Modelling and simulation are important decision tools that can be used to control human and animal diseases [1, 22, 31, 35]. However, since each disease exhibits its own biological characteristics, the models need to be adapted to each specific case to be able to handle real situations [6, 45].

In a previous work [23], we presented a spatial-temporal epidemiological model, called Be-CoDiS (Between-Countries Disease Spread), for the study of the spread of human diseases between and within countries. This model is an adaptation of a previous one, called Be-FAST (Between Farm Animal Spatial Transmission), which simulates the spread of animal diseases between and within farms [22, 31, 29, 30, 28]. Be-CoDiS is based on the combination of a deterministic Individual-Based model (where countries are considered as individuals) [11], simulating the between-country

2010 *Mathematics Subject Classification*. 92D30, 92C60, 34D20, 34K28.

Key words and phrases. Epidemiological modelling; deterministic models; stability analysis; sensitivity analysis; ebola virus disease; basic reproduction ratio.

©2020 Texas State University.

Submitted April 24, 2020. Published June 18, 2020.

interactions (here, migratory flux, also considered in other works such as [8, 25]) and disease spread, with a deterministic compartmental model [6, 17] (a system of ordinary differential equations), simulating the within-country disease spread. At the end of a simulation, Be-CoDiS returns outputs referring to outbreaks characteristics (for instance, the epidemic magnitude, the risk of disease introduction or spread per country, etc.). The main characteristic of this approach is the consideration of the following effects at the same time: migratory flux between countries, control measure effects and dynamic model parameters fitted to each country. Then, as a second part of that work, Be-CoDiS was validated by considering the case of the 2014-16 West African Ebola Virus Disease (EVD) epidemic [15, 7, 16, 44]. EVD is a human and primate virus disease that causes a high mortality rate (between 50% and 90%) [14, 33]. During the period from December 2013 to March 2016, several important outbreaks were reported in West Africa (Guinea, Liberia, Sierra Leone and Nigeria). Furthermore, 16 isolated cases were detected in Mali, Senegal, the USA, the United Kingdom, Italy and Spain. The outbreak was considered over on March 29th 2016. It is estimated that around 28616 people were infected during those outbreaks and 11310 deaths were reported [43]. Starting with data from December 2013, Be-CoDiS predicted (see [23]) a total of 28475 infected people, 11797 deaths and that the epidemic would end on April 19th, 2016.

Once the model (available at: <https://www.ucm.es/momat/epidemics>) was developed and validated, it would be good idea to study its mathematical properties. Its properties can be important for extracting conclusions that can be used in further analysis and/or developments of the model.

In this article, we perform a stability analysis of two simplified versions of Be-CoDiS. To this aim, we first analyze the equilibrium states of the model by considering only one country. More precisely, by applying the so-called next generation matrix method [36], we estimate an analytical expression of the disease basic reproduction ratio [3, 12, 13], denoted by R_0 according to the model parameters. The basic reproduction ratio associated to a disease free equilibrium, is used in epidemiology to determine the behavior of an epidemic. It is defined as the average number of new infections caused by one infected individual in a population in the conditions of a disease free equilibrium, over the course of its infectious period [1, 6]. We note that the mathematical definition of R_0 used in this paper is specific to deterministic finite dimensional systems such as those considered here [36, 46]. It is generally expected that if $R_0 > 1$ then the epidemic becomes endemic, whereas if $R_0 < 1$ then the epidemic tends to a disease free equilibrium [1, 3]. What is expected for $R_0 = 1$ is not always clear. Here, by considering particular techniques and results from [2, 34], we show that, if $R_0 \leq 1$, then the epidemic converges to a disease free equilibrium; otherwise, the epidemic does not disappear. We highlight the fact that the proposed approach is based on specific results not commonly used in the literature.

Then, we extend this study to the case of two countries, when one country sends infected people to other country. Finally, we validate and illustrate the theoretical results obtained here, with numerical experiments based on data from the 2014-16 West African Ebola virus epidemic and perform a sensitivity analysis of the estimated basic reproduction ratio, with respect to the model parameters.

This work is organized as follows. In Section 2, we recall the formulation of the Be-CoDiS model presented in [23]. In Section 3, we study the equilibrium states of

simplified versions of this model for one and two countries. In Section 4, considering data from the 2014-16 West African Ebola virus epidemic, we validate and illustrate the theoretical results with numerical experiments and perform a sensitivity analysis of the basic reproduction ratio with respect to the model parameters. Finally, in Section 5, we explain our conclusions.

2. BE-CODIS MODEL FORMULATION

We consider a disease with the following states for people (see [23, 26, 32, 33, 44]):

- Susceptible (denoted by S): A person that is not infected by the disease pathogen.
- Infected (denoted by E): A person that is infected by the disease pathogen but cannot infect other people and has no visible clinical signs (e.g., fever, haemorrhages, etc.). After an incubation period, the person passes to the infectious state.
- Infectious (denoted by I): A person that can infect other people and start developing clinical signs. The mean duration of a person in this state is called the infectious period. After this period, infectious people are detected by sanitary authorities and hospitalized.
- Hospitalized (denoted by H): A person that is hospitalized and can still infect other people. At the end of this state, the person can pass either to the Recovered state or to the Dead state. We point out that state H does not include hospitalized people which cannot infect other people any more. This last category of people is included in the Recovered state explained below.
- Dead (denoted by D): A person that did not survive the disease. The cadavers of infected people can infect other people until they are buried. After a fixed average time, the body is buried.
- Buried (denoted by B): A person that is dead because of the disease. His/her cadaver is buried and can no longer infect other people.
- Recovered (denoted by R): A person that survived the disease, is no longer infectious and develops a natural immunity to the disease pathogen.

After an infected person is hospitalized, the authorities may apply various control measures to control the disease spread (see [15, 19]):

- Isolation: Infected people are isolated from contact with other people. Only sanitary professionals are in contact with them. However, depending on the considered disease, contamination of those professionals may also occur (see [15]). Isolated people receive an adequate medical treatment that reduces the disease fatality rate.
- Quarantine: Movement of people in the area of origin of an infected person is restricted and controlled (e.g., quick sanitary check-points at the airports) to avoid potential infected people spreading the disease.
- Tracing: The objective of tracing is to identify potential infectious contacts which may have infected a person or spread the disease to other people.
- Increase of sanitary resources: The number of operational beds and sanitary personnel available to detect and treat affected people is increased. When necessary, the funerals of infected cadavers are controlled by sanitary personnel in order to reduce the contacts between the dead bodies and susceptible people.

Considering those general disease and control measures, the Be-CoDiS model is used to evaluate the spread of a human disease within and between countries during a fixed time interval.

At the beginning of the simulation, the model parameters are set by the user. At the initial time ($t = 0$), only susceptible people live in the countries that are free of the disease, whereas the number of people in states S , E , I , H , R , D and B of the infected countries are set to their corresponding values. Then, during the time interval $[0, T_{\max}]$, with $T_{\max} \in \mathbb{N}$ being the maximum number of simulation days, within-country and between-country daily spread procedures, are applied. If at the end of a simulation day t , the number of people in state E , I , H and D is lower than a fixed threshold (smaller than 1), the simulation is stopped. Else, the simulation ends when $t = T_{\max}$. Furthermore, the control measures are also implemented and they can be activated or deactivated, when starting the model, in order to quantify their effectiveness to reduce the magnitude and duration of an epidemic.

The spread of a disease within a particular country is modelled by using a deterministic compartmental model (see [6]). For the sake of simplicity, we assume that, at each time, the population inside a country is homogeneously distributed and constant. Thus, the spatial distribution of the epidemic inside a country can be omitted. We also suppose that new births are susceptible people and the birth rate is, for the sake of simplicity, equal to the death rate (due to the disease or other causes).

The disease spread between countries is modelled by using a spatial deterministic Individual Based model (see [11]), based on a population level transmission model. We consider that the flow of people between countries i and j at time t (i.e., people travelling per day from i to j at time t), is the only way to introduce the disease from country i , infected by the disease, to country j . To do so, we consider the matrix $(\tau_{i,j})_{i,j=1}^{N_{CO}}$, where $\tau_{i,j} \in [0, 1]$ is the rate of transfer (day^{-1}) of people from country i to country j , which is expressed in % of population in i per day. Furthermore, we assume that only people in states S and E can travel (we could also include here people in R , if it is suitable to do that), as other categories are not in condition to perform trips due to the clinical signs or to quarantine. Moreover, as a result of control measures in countries i and j , we assume that those rates can vary in time and are multiplied by a function denoted by $m_{\text{tr},i,j}(t)$.

Under those assumptions, the evolution of $S_i(t)$, $E_i(t)$, $I_i(t)$, $H_i(t)$, $R_i(t)$, $D_i(t)$ and $B_i(t)$, denoting the number of susceptible, infected, infectious, hospitalized, recovered, dead and buried people in country i at time t , respectively, is modelled

by the system of ordinary differential equations [23]

$$\begin{aligned}
\frac{dS_i}{dt}(t) &= -\frac{S_i(t)(m_{I,i}(t)\beta_{I,i}I_i(t) + m_{H,i}(t)\beta_{H,i}H_i(t) + m_{D,i}(t)\beta_{D,i}D_i(t))}{NP_i(t)} \\
&\quad - \mu_{m,i}S_i(t) + \mu_{n,i}\left(S_i(t) + E_i(t) + I_i(t) + H_i(t) + R_i(t)\right) \\
&\quad + \sum_{i \neq j} m_{\text{tr},j,i}(t)\tau_{j,i}S_j(t) - \sum_{i \neq j} m_{\text{tr},i,j}(t)\tau_{i,j}S_i(t), \\
\frac{dE_i}{dt}(t) &= \frac{S_i(t)(m_{I,i}(t)\beta_{I,i}I_i(t) + m_{H,i}(t)\beta_{H,i}H_i(t) + m_{D,i}(t)\beta_{D,i}D_i(t))}{NP_i(t)} \\
&\quad - \mu_{m,i}E_i(t) + \sum_{i \neq j} m_{\text{tr},j,i}(t)\tau_{j,i}\mathbb{X}_{\epsilon_{\text{fit}}}(E_j(t)) \\
&\quad - \sum_{i \neq j} m_{\text{tr},i,j}(t)\tau_{i,j}\mathbb{X}_{\epsilon_{\text{fit}}}(E_i(t)) - \gamma_E\mathbb{X}_{\epsilon_{\text{fit}}}(E_i(t)), \tag{2.1}
\end{aligned}$$

$$\frac{dI_i}{dt}(t) = \gamma_E\mathbb{X}_{\epsilon_{\text{fit}}}(E_i(t)) - (\mu_{m,i} + \gamma_{I,i}(t))I_i(t),$$

$$\frac{dH_i}{dt}(t) = \gamma_{I,i}(t)I_i(t) - \left(\mu_{m,i} + (1 - \omega_i(t))\gamma_{HR,i}(t) + \omega_i(t)\gamma_{HD,i}(t)\right)H_i(t),$$

$$\frac{dR_i}{dt}(t) = (1 - \omega_i(t))\gamma_{HR,i}(t)H_i(t) - \mu_{m,i}R_i(t),$$

$$\frac{dD_i}{dt}(t) = \omega_i(t)\gamma_{HD,i}(t)H_i(t) - \gamma_D D_i(t),$$

$$\frac{dB_i}{dt}(t) = \gamma_D D_i(t),$$

where

- $i \in \{1, \dots, N_{\text{CO}}\}$ is the index of each country.
- $N_{\text{CO}} \in \mathbb{N}$ is the number of countries.
- $NP_i(t) = S_i(t) + E_i(t) + I_i(t) + H_i(t) + R_i(t) + D_i(t)$ is the number of people (alive and also died because of the disease) in country i at time t .
- $\mu_{n,i} \in [0, 1]$ is the birth rate (day^{-1}) in country i : the number of births per day and per capita.
- $\mu_{m,i} \in [0, 1]$ is the mortality rate (day^{-1}) in country i : the number of deaths per day and per capita (or, equivalently, the inverse of the mean life expectancy (day) of a person).
- $\beta_{I,i} \in \mathbb{R}^+$ is the disease effective contact rate (day^{-1}) of a person in state I in country i : the mean number of effective contacts (i.e., contacts sufficient to transmit the disease) of a person in state I per day before applying control measures.
- $\beta_{H,i} \in \mathbb{R}^+$ is the disease effective contact rate (day^{-1}) of a person in state H in country i .
- $\beta_{D,i} \in \mathbb{R}^+$ is the disease effective contact rate (day^{-1}) of a person in state D in country i .
- $\gamma_E(i, t)$, $\gamma_{I,i}(t)$ and $\gamma_D(i, t) \in (0, +\infty)$ denote the transition rate (day^{-1}) from state E , I or D to state I , H or B , respectively: the number of people per day and per capita passing from one state to the other (or, equivalently, the inverse of the mean duration of one of those people in state E , I or D , respectively). We note that those parameters are time and country

dependent, since, due to the applied control measures in country i , their value could vary in time.

- $\gamma_{HR,i}(t)$ and $\gamma_{HD,i}(t)$ denote the transition rate (day^{-1}) from state H to state R (for people surviving the disease) and D (for people not surviving the disease), respectively. Here, we assume that the values of $\gamma_{HR,i}(t)$ and $\gamma_{HD,i}(t)$ are very close. Indeed, focusing on EVD, it has been observed that a person in state H passes to state R or S in around 4.5 days [26]. If values of $\gamma_{HR,i}(t)$ and $\gamma_{HD,i}(t)$ are different, the flow from I to H should be split into two sub flows, one from I to H_R (hospitalized people surviving the disease), and other one from I to H_D (hospitalized people not surviving the disease), with corresponding new flows from H_R to R and from H_D to D .
- $\omega_i(t) \in [0, 1]$ is the disease fatality rate in country i at time t : the proportion of people who do not survive the disease.
- $m_{I,i}(t)$, $m_{H,i}(t)$, $m_{D,i}(t) \in [0, 1]$ (%) are functions representing the efficiency of the control measures applied to non-hospitalized infectious people, hospitalized people and infected cadavers respectively, in country i at time t to eradicate the outbreaks. Focusing on the application of the control measures, we multiply the disease contact rates (i.e., $\beta_{I,i}$, $\beta_{H,i}$ and $\beta_{D,i}$) by decreasing functions simulating the reduction of the number of effective contacts as the control measures efficiency is improved. Here, we have considered the functions (see [27]):

$$m_{I,i}(t) = m_{H,i}(t) = m_{D,i}(t) = \exp\left(-\kappa_i \max(t - \lambda_i, 0)\right), \quad (2.2)$$

where κ_i in $[0, +\infty)$ (day^{-1}) simulates the efficiency of the control measures (greater value implies lower value of disease contact rates) and λ_i in $\mathbb{R} \cup \{+\infty\}$ (day) denotes the first day of application of those control measures.

- $\mathbb{X}_{\epsilon_{\text{fit}}}(x) = x$ if $x \geq \epsilon_{\text{fit}}$, $\mathbb{X}_{\epsilon_{\text{fit}}}(x) = 2x - \epsilon_{\text{fit}}$ if $(\epsilon_{\text{fit}}/2) \leq x \leq \epsilon_{\text{fit}}$, and 0 elsewhere, with $\epsilon_{\text{fit}} \geq 0$ being a small tolerance parameter. This function, with ϵ_{fit} small enough, is a filter used to avoid artificial spread of the epidemic due to negligible values of x .

System (2.1) is completed with initial data $S_i(0)$, $E_i(0)$, $I_i(0)$, $H_i(0)$, $R_i(0)$, $D_i(0)$ and $B_i(0)$ given in $[0, +\infty)$; for $i \in \{1, \dots, N_{\text{CO}}\}$. Model (2.1) is summarized in Figure 1.

Remark 2.1. We note that the Be-CoDiS model proposed here is not only limited to the study of the EVD, but can also tackle other diseases, such as the Middle East respiratory syndrome-related coronavirus (MERS) or the Severe acute respiratory syndrome coronavirus 2 (SARS-CoV-2) [9, 24, 21], by adapting the compartmental model and its parameters.

3. ANALYTICAL BEHAVIOR OF THE BE-CODIS MODEL

Here, we are interested in studying the equilibrium states and in estimating the basic reproduction ratio of simplified versions of the Be-CoDiS model presented in Section 2. First, we focus on the case of one country with an emigration flow of susceptible or infected people and an immigration flow of susceptible people. Then,

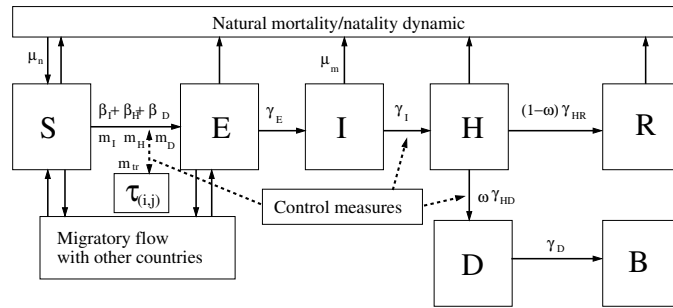

FIGURE 1. Summary of the complete version of the Be-CoDiS model.

we extend the study to the case of two countries, with one country sending people to the other one.

3.1. Simplified model for one country. Here, we are interested in studying the behavior of the epidemic inside one single country (i.e., we omit to study the spread in other countries). Additionally, we assume that this country send infected people to other countries, but does not receive infected people from other countries. Those assumptions are suitable if we consider that this country is the index case (i.e., the country of origin of the disease) and the spread of the disease to other countries is not expected. For the sake of simplicity, we assume that the population size in the considered country is constant and equal to $N \in \mathbb{N}$ (i.e., emigration or death flows are compensated by immigration or birth flows entering the susceptible state). This hypothesis is reasonable as, due to the size of the population in a country (generally larger than a million of people) and the time scale of the study (generally lower than five years) considered here, the global variation of the population size during a simulation is negligible [20].

To avoid asymptotic endemic solutions with the whole population concentrated in state B , the flow from state D to state B is replaced by a flow from state D to state S and state B is omitted. We note that this change in the model satisfies the hypothesis mentioned previously that deaths are replaced by immigration or births in the susceptible state in order to keep constant the size of the population. Furthermore, to simplify notations, we consider that S, E, I, H, R and D denote the ratio of people in each state in the considered country (rather than the total number of people). Additionally, we assume that the model coefficients are constant and no control measures are applied. As no other country is considered, the filter $\mathbb{X}_{\epsilon_{fit}}$ is omitted. A diagram of this model for one country is shown in Figure 2.

Under these assumptions, the evolution of the epidemic, is modelled by

$$\begin{aligned} \frac{dS}{dt}(t) &= -S(t)\left(\beta_I I(t) + \beta_H H(t) + \beta_D D(t)\right) + \tau E(t) \\ &\quad + \mu\left(E(t) + I(t) + H(t) + R(t)\right) + \theta D(t), \end{aligned} \tag{3.1}$$

$$\frac{dE}{dt}(t) = S(t)\left(\beta_I I(t) + \beta_H H(t) + \beta_D D(t)\right) - (\mu + \delta + \tau)E(t), \tag{3.2}$$

$$\frac{dI}{dt}(t) = \delta E(t) - (\mu + \gamma)I(t), \tag{3.3}$$

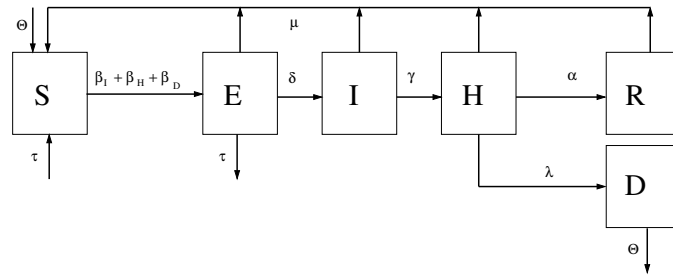

FIGURE 2. Simplified model with one country considered in Section 3.1.

$$\frac{dH}{dt}(t) = \gamma I(t) - (\mu + \lambda + \alpha)H(t), \quad (3.4)$$

$$\text{labelmod} \frac{dR}{dt}(t) = \alpha H(t) - \mu R(t),$$

$$\frac{dD}{dt}(t) = \lambda H(t) - \theta D(t), \quad (3.5)$$

where

- $\mu \in [0, 1]$ is the mortality rate (day^{-1}).
- $\beta_I \in \mathbb{R}^+$ is the disease effective contact rate ($\text{day}^{-1} \cdot \text{person}^{-1}$) of people in state I .
- $\beta_H \in \mathbb{R}^+$ is the disease effective contact rate ($\text{day}^{-1} \cdot \text{person}^{-1}$) of people in state H .
- $\beta_D \in \mathbb{R}^+$ is the disease effective contact rate ($\text{day}^{-1} \cdot \text{person}^{-1}$) of people in state D .
- δ, γ and θ denote the transition rates (day^{-1}) from state E to I , I to H and D to S , respectively.
- λ is the disease fatality percentage times the transition rate from state H to state D .
- α is the disease survival percentage (1 minus the disease fatality percentage) times the transition rate from state H to state R .
- $\tau \in [0, 1]$ is the daily rate (%) of the movement of people in states S or E .

We point out that, to keep constant the population, people leaving the country for unit of time (i.e., $\tau(S + E)$) and people being buried for unit of time (i.e., θD) are added to the susceptible state.

The main parameters used in this work and their corresponding range of values used in Section 4 are summarized in Table 1.

For convenience, we write the solutions of (3.5) as vectors $(E(t), I(t), H(t), D(t), S(t), R(t)) \in [0, 1]^6$, for all $t \geq 0$. We also consider $\Omega = \{(E, I, H, D, S, R) \in [0, 1]^6 : E + I + H + D + S + R = 1\}$.

Theorem 3.1. *The set Ω is positively invariant for system (3.5) (i.e., if $(E(0), I(0), \dots, R(0)) \in \Omega$, then $(E(t), I(t), \dots, R(t)) \in \Omega$, for all $t > 0$).*

Proof. First, we note that system (3.5) is positive (i.e., if $(E(0), \dots, R(0)) \in [0, +\infty)^6$, then $(E(t), \dots, R(t)) \in [0, +\infty)^6$, for all $t > 0$). Indeed, if $(E(t), \dots, R(t)) \in [0, +\infty)^6$ and $S(t) = 0$, then $\frac{dS(t)}{dt} \geq 0$, which guarantees that S cannot become

TABLE 1. Summary of the main notations used in this work. A brief description (Description) and the range (i.e., minimum and maximum values) of the values (Range of Value) used in Section 4, with $i \in \{1, 2\}$.

Notation	Range of Value	Description
β_{Ii}	[0.0494,0.2671]	Disease effective contact rate ($\text{day}^{-1}\text{person}^{-1}$) of people in state I in country i
β_{Hi}	[0.0107,0.0200]	Disease effective contact rate ($\text{day}^{-1}\text{person}^{-1}$) of people in state H in country i
β_{Di}	[0.0494,0.2671]	Disease effective contact rate ($\text{day}^{-1}\text{person}^{-1}$) of people in state D in country i
δ_i	[0.0120,0.0230]	Transition rate (day^{-1}) from state E to state I in country i
γ_i	[0.2000,0.5000]	Transition rate (day^{-1}) from state I to state H in country i
α_i	[0.1050,0.1480]	Disease survival proportion times transition rate (day^{-1}) from state H to state R
λ_i	[0.0328,0.1282]	Disease fatality rate times transition rate (day^{-1}) from state H to state D
θ_i	[0.5000,1.0000]	Transition rate (day^{-1}) from state D to state S in country i
μ_i	[0.012,0.023]	Natural mortality rate (day^{-1}) in country i
τ_i	$[0,2.4] \cdot 10^{-5}$	Daily rate ($\% \text{day}^{-1}$) of the movement of people leaving country i
N_i	$[10,20] \cdot 10^6$	Number of people in country i
$S_i, E_i, I_i, H_i, R_i, D_i$	[0,1]	proportion (%) of people in state S, E, I, H, R, D in country i at time t

negative. This property is also true for the other disease states, ensuring the positivity of the considered system.

Additionally, since $\frac{dE}{dt} + \frac{dI}{dt} + \frac{dH}{dt} + \frac{dD}{dt} + \frac{dS}{dt} + \frac{dR}{dt} = 0$, we have that $E(t) + I(t) + H(t) + D(t) + S(t) + R(t) = E(0) + I(0) + H(0) + D(0) + S(0) + R(0) = 1$ for all $t \geq 0$. Thus, we deduce that Ω is positively invariant for system (3.5). \square

For the study of the stability properties of system (3.5), we will use the basic reproduction ratio R_0 , which is the average number of secondary cases produced by one infected individual during its entire infectious period in an otherwise uninfected population [1, 18].

From a mathematical point of view, the value of R_0 associated to the epidemiological compartmental model (3.5) can be computed as the spectral radius of the so-called next generation matrix (see [36] for more details) as explained below.

More precisely, let us consider a general compartmental model for infectious disease transmission, defined (following the notation used in [34]) by

$$\begin{aligned} \dot{X} &= \mathcal{F}(X, Y) - \mathcal{V}(X, Y) \\ \dot{Y} &= g(X, Y), \end{aligned} \tag{3.6}$$

where vectors $X = (x_1, \dots, x_n)^T \in \mathbb{R}^n$ and $Y = (y_1, \dots, y_m)^T \in \mathbb{R}^m$ represent the populations in infected and non-infected states, respectively; vector $\mathcal{F} = (\mathcal{F}_1,$

$\mathcal{F}_2, \dots, \mathcal{F}_n)^T$, with \mathcal{F}_i being the rate of appearance of news infections in compartment i ; vector $\mathcal{V} = (\mathcal{V}_1, \mathcal{V}_2, \dots, \mathcal{V}_n)^T$, with \mathcal{V}_i being the rate of transfer of individuals out of (for positive values) or into (for negative values) compartment by all other means; and vector $g = (g_1, \dots, g_m)^T$ represents the transition terms for non-infected states.

Following [34, 37], we assume that:

- (A1) All functions \mathcal{F}_i , \mathcal{V}_i and g_i are $\mathcal{C}^2([0, 1]^{n+m}; \mathbb{R})$.
- (A2) $\mathcal{F}(0, Y) = \mathcal{V}(0, Y) = 0$ (if the population is free of disease then it will remain free of disease).
- (A3) $\mathcal{F}_i(X, Y) \geq 0$ for all $i \in \{1, \dots, n\}$ if X, Y satisfy $x_i \geq 0$ and $y_j \geq 0$ for all $(i, j) \in \{1, \dots, n\} \times \{1, \dots, m\}$.
- (A4) Given $i \in \{1, \dots, n\}$, $\mathcal{V}_i(X, Y) \leq 0$ if vector X satisfies $x_i = 0$; Given $j \in \{1, \dots, m\}$, $g_j(X, Y) \geq 0$ if vector Y satisfies $y_j = 0$, (if a compartment is empty, then there can be no transfer of individuals out of the compartment).
- (A5) $\sum_{i=1}^n \mathcal{V}_i(X, Y) \geq 0$ for all X, Y such that $x_i \geq 0$ and $y_j \geq 0$, for all $(i, j) \in \{1, \dots, n\} \times \{1, \dots, m\}$ (the total outflow from all infected compartments is non negative).
- (A6) The disease-free system $\dot{Y} = g(0, Y)$ has a unique equilibrium $Y_f \in \Omega_Y = \{Y \in [0, 1]^m : Y_1 + \dots + Y_m = 1\}$ which is globally asymptotically stable in Ω_Y .

Therefore, using assumptions (A1)–(A6), $P_f = (X_f, Y_f)$, with $X_f = (0, \dots, 0)$, is the unique admissible disease free equilibrium for system (3.6); we refer to this point as the disease-free equilibrium. Furthermore, there will be a unique basic reproduction ratio R_0 , the one associated to P_f , which can be computed as follows: Let

$$F = \left[\frac{\partial \mathcal{F}_i}{\partial x_j}(P_f) \right]_{i,j=1}^n \quad \text{and} \quad V = \left[\frac{\partial \mathcal{V}_i}{\partial x_j}(P_f) \right]_{i,j=1}^n. \quad (3.7)$$

From assumptions (A1)–(A6) we have (see [37, page 174]) that, if V is nonsingular and F and V^{-1} are non-negative matrices (i.e., square matrices all of whose elements are nonnegative), then the basic reproduction ratio associated with P_f is given by $R_0 = \rho(FV^{-1})$, the spectral radius of matrix FV^{-1} (see [36], page 33), which is the so called next generation matrix.

Taking into consideration this result, we introduce the following formulation of system (3.5). Let $P = (X, Y)^T$, with $X = (E, I, H, D)^T$ and $Y = (S, R)^T$. system (3.5) can be rewritten as system (3.6), where $\mathcal{F}(X, Y) = \tilde{\mathcal{F}}(S)X$, $\mathcal{V}(X, Y) = \tilde{\mathcal{V}}X$ and $g(X, Y) = \tilde{g}(S) \begin{pmatrix} X \\ Y \end{pmatrix}$, with

$$\tilde{\mathcal{F}}(S) = \begin{pmatrix} 0 & \beta_I S & \beta_H S & \beta_D S \\ 0 & 0 & 0 & 0 \\ 0 & 0 & 0 & 0 \\ 0 & 0 & 0 & 0 \end{pmatrix},$$

$$\tilde{\mathcal{V}} = \begin{pmatrix} (\mu + \delta + \tau) & 0 & 0 & 0 \\ -\delta & (\mu + \gamma) & 0 & 0 \\ 0 & -\gamma & (\mu + \lambda + \alpha) & 0 \\ 0 & 0 & -\lambda & \theta \end{pmatrix},$$

$$\tilde{g}(S) = \begin{pmatrix} \mu + \tau & \mu - \beta_I S & \mu - \beta_H S & \theta - \beta_D S & 0 & \mu \\ 0 & 0 & \alpha & 0 & 0 & -\mu \end{pmatrix}.$$

Theorem 3.2. *The basic reproduction ratio of system (3.5) is*

$$R_0 = \frac{\delta(\alpha\theta\beta_I + \gamma\lambda\beta_D + \gamma\theta\beta_H + \lambda\theta\beta_I + \mu\theta\beta_I)}{(\mu + \delta + \tau)(\mu + \gamma)(\mu + \lambda + \alpha)\theta}. \tag{3.8}$$

Proof. To compute the basic reproduction ratio of system (3.5), we apply the Next Generation Matrix methodology briefly described above (see [36]). We first rewrite (as done above) system (3.5) as (3.6) and notice that the assumptions (A1)–(A5) are satisfied. To check (A6), we consider the system $\dot{Y} = g(0, Y)$ which is given by

$$\begin{aligned} \frac{dS}{dt}(t) &= \mu R(t), \\ \frac{dR}{dt}(t) &= -\mu R(t). \end{aligned} \tag{3.9}$$

In $\Omega_Y = \{(S, R)^T \in [0, 1]^2 : S + R = 1\}$, the solutions of system (3.9) satisfy

$$\frac{dS}{dt}(t) = \mu R(t) = \mu(1 - S(t)).$$

Thus, $(S(t), R(t))^T = (1 - R(0)e^{-\mu t}, R(0)e^{-\mu t})$ is the unique solution of (3.9) in Ω_Y , once an initial value $R(0) \in [0, 1]$ is given, and $Y_f = (1, 0)^T$ is its unique equilibrium point in Ω_Y , which is globally asymptotically stable. Therefore, all the assumptions (A1)–(A6), detailed above, are satisfied.

Matrices $F = [\frac{\partial \mathcal{F}_i}{\partial x_j}(P_f)]_{i,j=1}^4$ and $V = [\frac{\partial \mathcal{V}_i}{\partial x_j}(P_f)]_{i,j=1}^4$ are given by

$$F = \begin{pmatrix} 0 & \beta_I & \beta_H & \beta_D \\ 0 & 0 & 0 & 0 \\ 0 & 0 & 0 & 0 \\ 0 & 0 & 0 & 0 \end{pmatrix}, \quad V = \tilde{V} = \begin{pmatrix} (\mu + \delta + \tau) & 0 & 0 & 0 \\ -\delta & (\mu + \gamma) & 0 & 0 \\ 0 & -\gamma & (\mu + \lambda + \alpha) & 0 \\ 0 & 0 & -\lambda & \theta \end{pmatrix}, \tag{3.10}$$

respectively. Furthermore, V is nonsingular,

$$V^{-1} = \begin{bmatrix} (\mu + \delta + \tau)^{-1} & 0 & 0 & 0 \\ \frac{\delta}{(\mu + \gamma)(\mu + \delta + \tau)} & (\mu + \gamma)^{-1} & 0 & 0 \\ \frac{\gamma\delta}{(\mu + \lambda + \alpha)(\mu + \gamma)(\mu + \delta + \tau)} & \frac{\gamma}{(\mu + \lambda + \alpha)(\mu + \gamma)} & (\mu + \lambda + \alpha)^{-1} & 0 \\ \frac{\lambda\gamma\delta}{(\mu + \lambda + \alpha)(\mu + \gamma)(\mu + \delta + \tau)\theta} & \frac{\lambda\gamma}{(\mu + \lambda + \alpha)(\mu + \gamma)\theta} & \frac{\lambda}{(\mu + \lambda + \alpha)\theta} & \theta^{-1} \end{bmatrix},$$

and

$$\begin{aligned} &FV^{-1} \\ &= \begin{bmatrix} \frac{\delta(\alpha\theta\beta_I + \gamma\lambda\beta_D + \gamma\theta\beta_H + \lambda\theta\beta_I + \mu\theta\beta_I)}{(\mu + \delta + \tau)(\mu + \gamma)(\mu + \lambda + \alpha)\theta} & \frac{\beta_I\theta(\mu + \lambda + \alpha) + \beta_H\gamma\theta + \beta_D\lambda\gamma}{(\mu + \lambda + \alpha)(\mu + \gamma)\theta} & \frac{\beta_H\theta + \beta_D\lambda}{(\mu + \lambda + \alpha)\theta} & \frac{\beta_D}{\theta} \\ 0 & 0 & 0 & 0 \\ 0 & 0 & 0 & 0 \\ 0 & 0 & 0 & 0 \end{bmatrix} \end{aligned}$$

It is clear that the eigenvalues of FV^{-1} are

$$\frac{\delta(\alpha\theta\beta_I + \gamma\lambda\beta_D + \gamma\theta\beta_H + \lambda\theta\beta_I + \mu\theta\beta_I)}{(\mu + \delta + \tau)(\mu + \gamma)(\mu + \lambda + \alpha)\theta}$$

(simple) and 0 (whose algebraic multiplicity is 3). Therefore, as claimed previously,

$$R_0 = \rho(FV^{-1}) = \frac{\delta(\alpha\theta\beta_I + \gamma\lambda\beta_D + \gamma\theta\beta_H + \lambda\theta\beta_I + \mu\theta\beta_I)}{(\mu + \delta + \tau)(\mu + \gamma)(\mu + \lambda + \alpha)\theta},$$

which is the value given in (3.8). □

Using the basic reproduction ratio R_0 given in (3.8), we have the following stability results.

Theorem 3.3. *With the notation used in (3.6), if (A1)–(A6) are satisfied, we have the following results:*

- (1) *The (unique) disease free equilibrium $P_f = (0, 0, 0, 0, 1, 0)$ of system (3.5) is globally asymptotically stable in Ω if $R_0 \leq 1$, and unstable if $R_0 > 1$.*
- (2) *If $R_0 > 1$, system (3.5) has, at least, one endemic disease equilibrium $P_e = (X_e, Y_e) \in \Omega$, with $X_e = (E_e, I_e, H_e, D_e)$ and $Y_e = (S_e, R_e)$ given by*

$$\begin{aligned} S_e &= \frac{1}{R_0}, & E_e &= \theta\mu(\mu + \gamma)(\mu + \alpha + \lambda)\phi, \\ I_e &= \delta\theta\mu(\mu + \alpha + \lambda)\phi, & H_e &= \delta\theta\gamma\mu\phi, \\ R_e &= \delta\theta\alpha\gamma\phi, & D_e &= \delta\gamma\lambda\mu\phi \\ \phi &= \frac{1}{(\delta\gamma\lambda(\mu - \theta) + (\mu + \delta + \tau)(\mu + \gamma)(\mu + \lambda + \alpha)\theta)} \left(1 - \frac{1}{R_0}\right). \end{aligned}$$

Before proving Theorem 3.3 we recall some results that will be used in the proof. We consider a general autonomous differential equation

$$\dot{x}(t) = f(x(t)), \quad t > 0, \quad (3.11)$$

such that $x \in \mathbb{R}^n$ and $f \in \mathcal{C}^0(\mathbb{R}^n, \mathbb{R}^n)$. Let us denote, for any function $V \in \mathcal{C}^1(U, \mathbb{R})$ with $U \subset \mathbb{R}^n$,

$$\dot{V}(x) = \nabla V(x)^T f(x). \quad (3.12)$$

Theorem 3.4. *Let $\mathcal{G} \subset \mathbb{R}^n$ be a compact and positively invariant set for system (3.11). Let $L \in \mathcal{C}^1(\mathcal{G}, \mathbb{R}^n)$ such that $\dot{L}(x) \leq 0$, for all $x \in \mathcal{G}$. We consider the following sets: $S_1 = \{x \in \mathcal{G} : L(x) = \min_{w \in \mathcal{G}} L(w)\}$; $S_2 = \{x \in \mathcal{G} : \dot{L}(x) = 0\}$ and S_3 the largest invariant set in S_2 for system (3.11). If $S_1 = S_3$, then, starting from any point in \mathcal{G} , system (3.11) converges asymptotically to S_3 .*

For a proof of the above theorem, see, for instance, [2, page 346].

Proof of Theorem 3.3. First, we determine the equilibrium states of system (3.6) by solving $(\tilde{\mathcal{F}}(S) - \tilde{\mathcal{V}})X = 0$ and $\tilde{g}(S)P = 0$. After some computation (with Maple 16), it can be proved that $P_f \in \Omega$ and P_e , given in the statement of Theorem 3.3, are equilibrium points. If $R_0 > 1$, $P_e \in \Omega$, else $R_0 \leq 1$, $P_e \notin \Omega$ (we also note that, if $R_0 > 1$ and tends to 1, then P_e tends to P_f).

Let us assume that $R_0 \leq 1$: To build a function L as defined in the statement of Theorem 3.4, we use a method developed in [34] to determine a Lyapunov function for the disease free points of system (3.6) (i.e., points such that $E = I = H = D = 0$). With that aim, the first line of system (3.6) is rewritten as

$$\dot{X} = (F - V)X - f(X, Y),$$

where F and V are defined in (3.7) and $f(X, Y) = (F - V)X - \mathcal{F}(X, Y) + \mathcal{V}(X, Y)$. Thus, in our case, from (3.10), we have that

$$f(X, Y) = (F - V)X - \tilde{\mathcal{F}}(S)X + \tilde{\mathcal{V}}X = (F - \tilde{\mathcal{F}}(S))X.$$

Matrices FV^{-1} and $V^{-1}F$ have the same eigenvalues (we remind that the products of AB and BA of two arbitrary matrices $A \in \mathcal{M}_{n \times m}$ and $B \in \mathcal{M}_{m \times n}$ have the same set of eigenvalues since, if u is an eigenvector of AB , then Bu is an eigenvector

of BA of the same eigenvalue), which are (as seen previously) R_0 (simple) and 0. Furthermore, it can be easily proved (for instance with symbolic computations done with Maple) that $w = (0, \beta_I, \beta_H, \beta_D)$ is a left eigenvector of $V^{-1}F$ corresponding to the eigenvalue R_0 .

Let $L_f : \mathbb{R}^4 \times \mathbb{R}^2 \rightarrow \mathbb{R}$ given by $L_f(X, Y) = wV^{-1}X$, which leads, by simple calculations, to

$$L_f(X, Y) = \left(\frac{\beta_I \delta}{(\mu + \gamma)(\mu + \delta + \tau)} + \frac{\beta_H \gamma \delta}{(\mu + \delta + \tau)(\mu + \lambda + \alpha)(\mu + \gamma)} + \frac{\beta_D \lambda \gamma \delta}{(\mu + \lambda + \alpha)(\mu + \gamma)(\mu + \delta + \tau)\theta} \right) E + \left(\frac{\beta_I}{(\mu + \gamma)} + \frac{\beta_H \gamma}{(\mu + \gamma)(\mu + \lambda + \alpha)} + \frac{\beta_D \lambda \gamma}{(\mu + \lambda + \alpha)(\mu + \gamma)\theta} \right) I + \left(\frac{\beta_H}{(\mu + \lambda + \alpha)} + \frac{\beta_D \lambda}{(\mu + \lambda + \alpha)\theta} \right) H + \frac{\beta_D}{\theta} D.$$

We note that L_f is non negative in Ω and, according to (3.12),

$$\dot{L}_f(X, Y) = wV^{-1}((F - V)X - f(X, Y)) = (R_0 - 1)wX - wV^{-1}f(X, Y).$$

Additionally, since $R_0 \leq 1$ and the coordinates of V^{-1} and $f(X, Y)$ are non negative for all $(X, Y) \in \Omega$ then $\dot{L}_f(X, Y) \leq 0$ for all $(X, Y) \in \Omega$.

Let $\Omega_f = \{(E, I, H, D, S, R) \in \Omega : E = I = H = D = 0\}$. If $x \in \Omega_f$, then $L_f(x) = 0$, and if $x \in \Omega \setminus \Omega_f$ then $L_f(x) > 0$.

Moreover, we note that $\dot{L}_f(X, Y) = 0$ if and only if $(R_0 - 1)wX = 0$, and

$$wV^{-1}f(X, Y) = \left(-\frac{\beta_I \delta}{(\mu + \gamma)(\mu + \delta + \tau)} - \frac{\beta_H \gamma \delta}{(\mu + \delta + \tau)(\mu + \lambda + \alpha)(\mu + \gamma)} - \frac{\beta_D \lambda \gamma \delta}{(\mu + \lambda + \alpha)(\mu + \gamma)(\mu + \delta + \tau)\theta} \right) (1 - S)(\beta_I I + \beta_H H + \beta_D D) = 0$$

From the first condition, we have that $I = H = D = 0$ if $R_0 < 1$ (no condition if $R_0 = 1$). From the second condition, we have that $S = 1$ (and $E = I = H = D = R = 0$) or $I = H = D = 0$.

Using the notation introduced in Theorem 3.4, we have that

- $S_1 = \{(X, Y) \in \Omega : L_f(X, Y) = \min_{W \in \Omega} L_f(W) = 0\} = \Omega_f$.
- $S_2 = \{(X, Y) \in \Omega : \dot{L}_f(X, Y) = 0\} = \{(X, Y) \in \Omega : I = H = D = 0\}$.
- $S_3 = \Omega_f$. Indeed, on the one hand, starting from any point in $S_2 \setminus \Omega_f$, we have that $E(0) > 0$ and $I(0) = 0$, thus, due to the third line of system (3.5), $\frac{dI}{dt}(0) > 0$ which implies that the trajectory gets out of S_2 . On the other hand, the solution of system (3.5) starting from any point in Ω_f , say, $(0, 0, 0, 0, 1 - R(0), R(0))$, with $R(0) \in [0, 1]$, is given by

$$(E(t), I(t), H(t), D(t), S(t), R(t)) = (0, 0, 0, 0, 1 - R(t), R(0) \exp(-\mu t)) \in \Omega_f$$

for any $t \geq 0$. Thus, Ω_f is positively invariant for system (3.5) and the largest invariant set in S_2 is $S_3 = \Omega_f$.

Since all the hypothesis of Theorem 3.4 are fulfilled, we deduce that system (3.5), starting from any point in Ω , converges asymptotically to Ω_f .

In particular, this implies that $\lim_{t \rightarrow +\infty} H(t) = 0$. From the fifth line of system (3.5) we have that

$$\frac{dR}{dt}(t) = \alpha H(t) - \mu R(t),$$

whose solution is given by $R(t) = R(0)e^{-t} + e^{-t} \int_0^t H(x)e^x dx$.

Let $K(t) = \int_0^t H(x)e^x dx$. Since $H(x)e^x \geq 0$ for any $x \in \mathbb{R}$, $K(t)$ is a non-decreasing and non-negative function. Thus, we have two cases:

- (1) $\lim_{t \rightarrow +\infty} K(t) \in \mathbb{R}$ which implies that $\lim_{t \rightarrow +\infty} R(t) = 0$.
- (2) $\lim_{t \rightarrow +\infty} K(t) = +\infty$. Then, applying L'Hôpital's rule, we obtain that

$$\lim_{t \rightarrow +\infty} R(t) = \lim_{t \rightarrow +\infty} e^{-t} \int_0^t H(x)e^x dx = \lim_{t \rightarrow +\infty} -e^{-t} H(t)e^t = \lim_{t \rightarrow +\infty} -H(t) = 0.$$

This implies $\lim_{t \rightarrow +\infty} R(t) = 0$ and $\lim_{t \rightarrow +\infty} S(t) = 1$. We conclude that P_f is globally asymptotically stable in Ω for system (3.5).

Let us assume that $R_0 > 1$. System (3.6) satisfies the hypothesis in [36, Theorem 2] and, thus, the equilibrium point P_f is unstable when $R_0 > 1$. \square

3.2. Simplified model for 2 countries. In this section, we study the epidemiological behavior of two countries. One of them (denoted by Country 2) receiving infected people from the other country (denoted by Country 1). We suppose no extra control measures are taken (so that $m_{i,j} = 1$) and take into account the same assumptions and notations (but indexed by $i = 1, 2$ according to the country) as those introduced in Section 3.1. For the sake of simplicity, we assume that each country has constant (in time) population, N_1 and N_2 , respectively, and movement of people from Country 1 to Country 2. This is a reasonable assumption since, for the typical duration of a EVD epidemic, the population of a country does not vary significantly.

Remark 3.5. The same formulation results for the case of two countries keeping constant populations, with movements from Country 1 to Country 2 and viceversa, with no movements from the infected state in Country 2 (E_2) to Country 1.

As usual (see [23]) only people in the susceptible (S) or infected (E) states are supposed to travel. The proportion of susceptible and infected people travelling, at time t , from Country 1 to Country 2 per unit time is $\tau_1 S_1(t)$ and $\tau_1 E_1(t)$, respectively. To keep constant populations in both countries, this rate of people is also reintroduced in the susceptible state of Country 1 and removed (after normalizing with the population of Country 2) from the susceptible state of the second country. Furthermore, to avoid removing too many people from the susceptible state in Country 2 in the extreme case (and clearly unrealistic) of having $E_1(t)$ much bigger than $S_2(t)$, we set a limit K (big enough) for the ratio, so that when $\frac{E_1(t)}{S_2(t)} \geq K$, only $\tilde{\tau}_1 K S_2(t)$ of $\tilde{\tau}_1 E_1(t)$ is removed from the susceptible state S_2 per unit time and the rest, $\tilde{\tau}_1 (E_1(t) - K S_2(t))$, is removed from the infected state E_2 , per unit time. Here, $\tilde{\tau}_1 = \tau_1 \frac{N_1}{N_2}$ represents the proportion of persons going from Country 1 to Country 2 per unit of time and relative to the population size N_2 .

More precisely, $\tau_1 E_1(t)$ is leaving the infected state E_1 and entering in the susceptible states S_1 per unit time, in Country 1. In Country 2, $\tilde{\tau}_1 E_1(t)$ is entering in the infected state $E_2(t)$ per unit time. Furthermore, to keep constant the population N_2 ,

- $\tilde{\tau}_1 \chi_K(E_1, S_2)$ is removed from the susceptible state S_2 per unit time, where $\chi_K : [0, 1]^2 \rightarrow \mathbf{R}$ is the continuous function defined by

$$\chi_K(x, y) = \min\{x, Ky\} = \begin{cases} x, & \text{if } x \leq Ky \\ Ky, & \text{if } x \geq Ky. \end{cases}$$

- The following quantity is removed from the infected state E_2 per unit time:

$$\tilde{\tau}_1 \max\{E_1 - KS_2, 0\} = \begin{cases} 0, & \text{if } E_1 \leq KS_2 \\ \tilde{\tau}_1(E_1 - KS_2), & \text{if } E_1 \geq KS_2 \end{cases}$$

We observe that the final balance of the proportion of infected people entering the infected state in Country 2 is

$$\tilde{\tau}_1(E_1 - \max\{E_1 - KS_2, 0\}) = \tilde{\tau}_1 \min\{E_1, KS_2\} = \tilde{\tau}_1 \chi_K(E_1, S_2).$$

Furthermore, following an idea in [23] to avoid unrealistic spread of the epidemic because of unrealistic negligible values of movement of people in the state E from one country to another, we consider only the contribution of infected individuals from Country 1 in Country 2, when the number of infected individuals in Country 1 (given by $N_1 E_1$) is greater than a given threshold $N_1 \epsilon > 0$. To do that, we set $\epsilon \geq 0$ (small enough) and change the function χ_K by the continuous function $\chi_{K,\epsilon} : [0, 1]^2 \rightarrow \mathbf{R}$ defined by

$$\chi_{K,\epsilon}(x, y) = \begin{cases} x, & \text{if } x \leq Ky \text{ and } x \geq \epsilon, \\ \frac{2x^2}{\epsilon} - x, & \text{if } x \leq Ky \text{ and } \epsilon \geq x \geq \epsilon/2, \\ Ky, & \text{if } x \geq Ky \text{ and } x \geq \epsilon \\ \frac{2Ky}{\epsilon}x - Ky, & \text{if } x \geq Ky \text{ and } \epsilon \geq x \geq \epsilon/2, \\ 0, & \text{if } x \leq \epsilon/2. \end{cases} \quad (3.13)$$

This function is a filter used to avoid artificial spread of the epidemic due to negligible values of $E_1(t)$ and to keep nonnegativity of the function $S_2(t)$ and constant population of the second country. We point out that, when $\epsilon = 0$, $\chi_{K,0}(E_1(t), S_2(t)) = \chi_K(E_1(t), S_2(t))$. A particular graphical representation of this function is depicted in Figure 3. A representation of the distribution of the analytical formulation of $\chi_{K,\epsilon}$ in the plane OXY is presented in Figure 4.

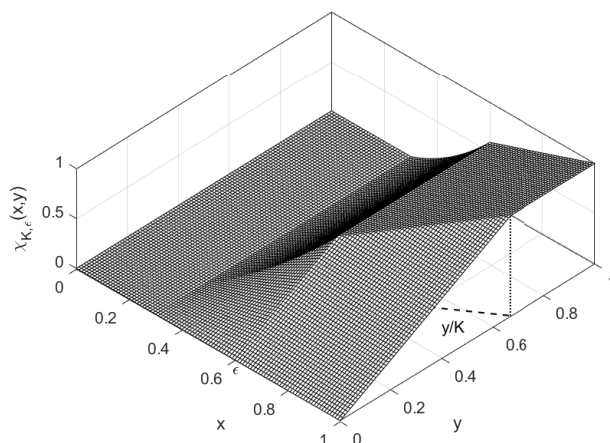
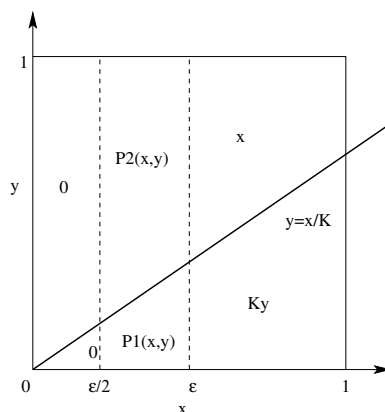
FIGURE 3. Representation of the function $\chi_{1.5,0.6}(x, y)$.FIGURE 4. Distribution of the analytical formulation of $\chi_{K,\epsilon}$ in the plane OXY . Here, $P1(x, y) = \frac{2Ky}{\epsilon}x - Ky$ and $P2(x, y) = \frac{2x^2}{\epsilon} - x$.

Taking into account these hypothesis, we now consider the two systems

$$\begin{aligned}
 \frac{dS_1}{dt}(t) &= -S_1(t) \left(\beta_{I,1}I_1(t) + \beta_{H,1}H_1(t) + \beta_{D,1}D_1(t) \right) \\
 &\quad + \tau_1 E_1(t) + \mu_1 \left(E_1(t) + I_1(t) + H_1(t) + R_1(t) \right) + \theta_1 D_1(t), \\
 \frac{dE_1}{dt}(t) &= S_1(t) \left(\beta_{I,1}I_1(t) + \beta_{H,1}H_1(t) + \beta_{D,1}D_1(t) \right) \\
 &\quad - (\mu_1 + \delta_1 + \tau_1) E_1(t), \\
 \frac{dI_1}{dt}(t) &= \delta_1 E_1(t) - (\mu_1 + \gamma_1) I_1(t), \\
 \frac{dH_1}{dt}(t) &= \gamma_1 I_1(t) - (\mu_1 + \lambda_1 + \alpha_1) H_1(t), \\
 \frac{dR_1}{dt}(t) &= \alpha_1 H_1(t) - \mu_1 R_1(t), \\
 \frac{dD_1}{dt}(t) &= \lambda_1 H_1(t) - \theta_1 D_1(t),
 \end{aligned} \tag{3.14}$$

and

$$\begin{aligned}
 \frac{dS_2}{dt}(t) &= -S_2(t)\left(\beta_{I,2}I_2(t) + \beta_{H,2}H_2(t) + \beta_{D,2}D_2(t)\right) \\
 &\quad - \tilde{\tau}_1 \mathbb{X}_{K,\epsilon}(E_1(t), S_2(t)) + \tau_2 E_2(t) \\
 &\quad + \mu_2\left(E_2(t) + I_2(t) + H_2(t) + R_2(t)\right) + \theta_2 D_2(t), \\
 \frac{dE_2}{dt}(t) &= S_2(t)\left(\beta_{I,2}I_2(t) + \beta_{H,2}H_2(t) + \beta_{D,2}D_2(t)\right) - (\mu_2 + \delta_2 + \tau_2)E_2(t) \\
 &\quad + \tilde{\tau}_1 \mathbb{X}_{K,\epsilon}(E_1(t), S_2(t)), \\
 \frac{dI_2}{dt}(t) &= \delta_2 E_2(t) - (\mu_2 + \gamma_2)I_2(t), \\
 \frac{dH_2}{dt}(t) &= \gamma_2 I_2(t) - (\mu_2 + \lambda_2 + \alpha_2)H_2(t), \\
 \frac{dR_2}{dt}(t) &= \alpha_2 H_2(t) - \mu_2 R_2(t), \\
 \frac{dD_2}{dt}(t) &= \lambda_2 H_2(t) - \theta_2 D_2(t),
 \end{aligned} \tag{3.15}$$

where all the constants involved are positive and denoting similar things as those of systems (2.1) and (3.5). A diagram summarizing this model is presented in Figure 5.

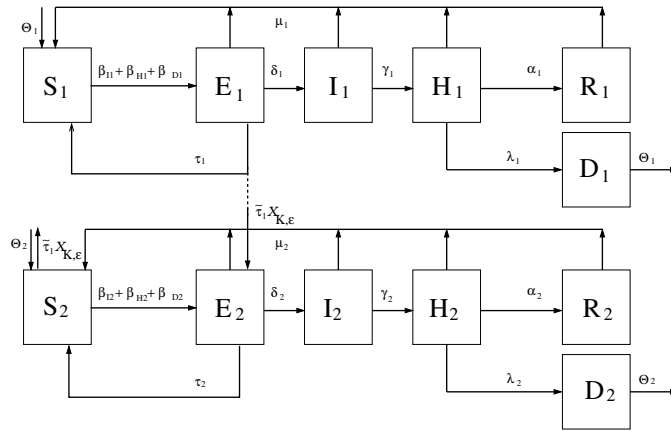

FIGURE 5. Simplified model with two countries considered in Section 3.2.

Let $\Omega^2 = \Omega \times \Omega = \{(E_1, I_1, H_1, D_1, S_1, R_1, E_2, I_2, H_2, D_2, S_2, R_2) \in [0, 1]^{12} : E_1 + I_1 + H_1 + D_1 + S_1 + R_1 = 1 \text{ and } E_2 + I_2 + H_2 + D_2 + S_2 + R_2 = 1\}$.

Theorem 3.6. *The set Ω^2 is positively invariant for system (3.14)-(3.15).*

Proof. Let $(E_1(0), I_1(0), \dots, R_2(0)) \in \Omega^2$. Since $(E_1(0), \dots, R_1(0)) \in \Omega$ and system (3.14) has the same structure as system (3.5), by Theorem 3.1, the solution $(E_1(t), I_1(t), H_1(t), D_1(t), S_1(t), R_1(t))$, which is governed by system (3.14), remains in Ω for all $t \in \mathbb{R}$.

Moreover, $(E_2(0), \dots, R_2(0)) \in \Omega$ implies that $(E_2(t), \dots, R_2(t)) \in \Omega$ for all $t \geq 0$. Indeed, if $S_2(t) = 0$, then $\frac{dS_2}{dt}(t) \geq 0$, which guarantees that S_2 cannot become negative. Same reasoning applies for E_2, I_2, H_2, D_2 and R_2 .

Additionally, since

$$\frac{dE_2}{dt}(t) + \frac{dI_2}{dt}(t) + \frac{dH_2}{dt}(t) + \frac{dD_2}{dt}(t) + \frac{dS_2}{dt}(t) + \frac{dR_2}{dt}(t) = 0,$$

we have that $E_2(t) + I_2(t) + H_2(t) + D_2(t) + S_2(t) + R_2(t) = E_2(0) + I_2(0) + H_2(0) + D_2(0) + S_2(0) + R_2(0) = 1$ for all $t \geq 0$. Thus, $(E_2(t), I_2(t), H_2(t), D_2(t), S_2(t), R_2(t))$ remains in Ω for all $t \in \mathbb{R}$. Thus, if $(E_1(0), I_1(0), \dots, R_2(0)) \in \Omega^2$, then for all $t \in \mathbb{R}$ $(E_1(t), I_1(t), \dots, R_2(t)) \in \Omega^2$. \square

Following the process in Theorem 3.2, we consider

$$R_{0,i} = \frac{\delta_i \alpha_i \theta_i \beta_{I,i} + \gamma_i \lambda_i \beta_{D,i} + \gamma_i \theta_i \beta_{H,i} + \lambda_i \theta_i \beta_{I,i} + \mu_i \theta_i \beta_{I,i}}{(\mu_i + \delta_i + \tau_i)(\mu_i + \gamma_i)(\mu_i + \lambda_i + \alpha_i) \theta_i}, \tag{3.16}$$

with $i = 1, 2$, which is helpful for studying the stability of system (3.14)-(3.15).

Theorem 3.7. *System (3.14)–(3.15) admits a disease free equilibrium $P_f = (P_{f,1}, P_{f,2})$, with $P_{f,1} = P_{f,2} = (0, 0, 0, 0, 1, 0)$. Furthermore, the following results hold:*

- (1) *If $R_{0,1} \leq 1$ and $R_{0,2} \leq 1$, then P_f is globally asymptotically stable.*
- (2) *If $R_{0,1} \leq 1$ and $R_{0,2} > 1$, then the solution $(E_1(t), I_1(t), H_1(t), D_1(t), S_1(t), R_1(t))$ of sub-system (3.14) with any initial data $(E_1(0), \dots, R_1(0)) \in \Omega$, tends to the disease free state $P_{f,1} = (0, 0, 0, 0, 1, 0)$ as $t \rightarrow \infty$, and there exists an endemic equilibrium $P_{e,2} = (E_{e,2}, I_{e,2}, H_{e,2}, D_{e,2}, S_{e,2}, R_{e,2}) \in \Omega$ for sub-system (3.15).*
- (3) *If $R_{0,1} > 1$, then $P_{f,1}$ is an unstable disease free equilibrium and there exists an endemic equilibrium $P_{e,1} = (E_{e,1}, I_{e,1}, H_{e,1}, D_{e,1}, S_{e,1}, R_{e,1})$ for sub-system (3.14). Additionally, if $(E_1, \dots, R_1, E_2, \dots, R_2)$ is a solution of (3.14)-(3.15) with $(E_1(0), \dots, R_1(0), E_2(0), \dots, R_2(0)) \in \Omega^2$ and $KS_2(t) > E_1(t) > \epsilon$ for all $t > 0$ (which is a reasonable assumption in real cases), then $E_2(t)$ does not converge to 0 as $t \rightarrow \infty$.*

Here, for $i = 1, 2$, we have $S_{e,i} = \frac{1}{R_{0,i}}$, $E_{e,i} = \theta_i \mu_i (\mu_i + \gamma_i) (\mu_i + \alpha_i + \lambda_i) \phi_i$, $I_{e,i} = \delta_i \theta_i \mu_i (\mu_i + \alpha_i + \lambda_i) \phi_i$, $H_{e,i} = \delta_i \theta_i \gamma_i \mu_i \phi_i$, $R_{e,i} = \delta_i \theta_i \alpha_i \gamma_i \phi_i$ and $D_{e,i} = \delta_i \gamma_i \lambda_i \mu_i \phi_i$, with

$$\phi_i = \frac{1}{(\delta_i \gamma_i \lambda_i (\mu_i - \theta_i) + (\mu_i + \delta_i + \tau_i)(\mu_i + \gamma_i)(\mu_i + \lambda_i + \alpha_i) \theta_i)} \left(1 - \frac{1}{R_{0,i}}\right).$$

Proof. It is obvious that P_f is always a disease free equilibrium. Let us prove the other points of the theorem.

(1) and (2): We first assume that $R_{0,1} \leq 1$. Since sub-system (3.14) is independent of sub-system (3.15) and similar to system (3.5), as proven in Theorem 3.3, $(E_1(t), I_1(t), H_1(t), D_1(t), S_1(t), R_1(t))$ converges to the disease free equilibrium $P_{f,1}$.

This implies that there exists a time $t_\epsilon > 0$, such that $E_1(t) < \frac{\epsilon}{2}$, for all $t > t_\epsilon$. Thus, for all $t > t_\epsilon$, $\mathbb{X}_{K,\epsilon}(E_1(t), S_2(t)) = 0$ and the first and second equations of sub-system (3.15) are given by

$$\frac{dS_2}{dt}(t) = -S_2(t) \left(\beta_{I,2} I_2(t) + \beta_{H,2} H_2(t) + \beta_{D,2} D_2(t) \right)$$

$$\begin{aligned}
& + \tau_2 E_2(t) + \mu_2 \left(E_2(t) + I_2(t) + H_2(t) + R_2(t) \right) + \theta_2 D_2(t), \\
\frac{dE_2}{dt}(t) & = S_2(t) \left(\beta_{I,2} I_2(t) + \beta_{H,2} H_2(t) + \beta_{D,2} D_2(t) \right) - (\mu_2 + \delta_2 + \tau_2) E_2(t).
\end{aligned}$$

Therefore, sub-system (3.15) is equivalent to system (3.5) for $t > t_\epsilon$ and, as proven in Theorem 3.3:

- If $R_{0,2} \leq 1$, then $(E_2(t), I_2(t), H_2(t), D_2(t), S_2(t), R_2(t))$ converges to the disease free equilibrium $P_{f,2}$ as $t \rightarrow \infty$.
- If $R_{0,2} > 1$, then the point $P_{e,2}$ given in the statement of Theorem 3.7 is an endemic equilibrium for sub-system (3.15).

(3) Assuming $R_{0,1} > 1$, from Theorem 3.3, we deduce that $P_{f,1}$ is an unstable disease free equilibrium, the point $P_{e,1}$ given in the statement of Theorem 3.7 is an endemic equilibrium point of sub-system (3.14) and $E_{e,1} > 0$.

Let us assume that for all $t > 0$, $K S_2(t) > E_1(t) > \epsilon$. By reductio ad absurdum, if $\lim_{t \rightarrow +\infty} E_2(t) = 0$, then there exists $t_1 > 0$ such that for all $t > t_1$, $E_2(t) < \frac{\tilde{\tau}_1 \epsilon}{2(\mu_2 + \delta_2 + \tau_2)}$. Additionally, from the second equation of sub-system (3.15),

$$\frac{dE_2(t)}{dt} \geq -(\mu_2 + \delta_2 + \tau_2) E_2(t) + \tilde{\tau}_1 \mathbb{X}_{K,\epsilon}(E_1(t), S_2(t)) > -\frac{\tilde{\tau}_1 \epsilon}{2} + \tilde{\tau}_1 E_1(t) > \frac{\tilde{\tau}_1 \epsilon}{2}$$

for all $t > t_1$. This implies that $\lim_{t \rightarrow +\infty} E_2(t) = +\infty$, which is not possible because, as said previously $0 \leq E_2(t) \leq 1$ for all $t \geq 0$ (see Theorem 3.6). Thus, $E_2(t)$ does not converge to 0 as $t \rightarrow \infty$. \square

Remark 3.8. From Theorem 3.7, we can define a basic reproduction ratio for the disease described by System (3.14)-(3.15) by considering $R_0 = \max(R_{0,1}, R_{0,2})$. Indeed, if $R_0 \leq 1$, System (3.14)-(3.15) converges globally and asymptotically to the disease free equilibrium $(0, 0, 0, 0, 1, 0, 0, 0, 0, 0, 1, 0)$, else, under reasonable hypothesis, it does not converges to this disease free state.

4. APPLICATION TO THE 2014-2016 WEST AFRICAN EVD EPIDEMICS

In this section, to validate and illustrate the interest of the theoretical results obtained previously, we present some numerical experiments based on data from the 2014-2016 West African EVD epidemics. To do so, in subsection 4.1, we perform a sensitivity analysis of the basic reproduction ratio studied in section 3.1, regarding the model parameters. This sensitivity analysis will be used later, in Section 5, to propose strategies to allocate the resources for fighting EVD. Next, in section 4.2, to exhibit the stability results highlighted in Theorem 3.7, we present the evolution of the epidemic between two countries by considering several sets of parameters.

4.1. Sensitivity analysis of the basic reproduction ratio. In Table 2, we show the maximum and minimum values of the parameters of System (3.5) reported in the literature for the 2014-2016 West African EVD case [7, 15, 16, 23, 32].

Considering those values, we study the impact of variations in each model parameter on the value of the basic reproduction ratio given in Theorem 3.3 and rewritten as a function

$$R_0(P) = \frac{\delta(\alpha\theta\beta_I + \gamma\lambda\beta_D + \gamma\theta\beta_H + \lambda\theta\beta_I + \mu\theta\beta_I)}{(\mu + \delta + \tau)(\mu + \gamma)(\mu + \lambda + \alpha)\theta}, \quad (4.1)$$

with $P = (\beta_I, \beta_D, \beta_H, \delta, \alpha, \theta, \gamma, \lambda, \mu, \tau) = (P_1, P_2, \dots, P_{10}) \in (0, +\infty)^9 \times [0, +\infty)$.

TABLE 2. Minimum and maximum values of the parameters of system (3.5) for the 2014-2016 West African EVD case.

Parameters	Unit	Minimum	Maximum
μ	(day ⁻¹)	0.0120	0.0230
τ	(day ⁻¹)	0	2.4×10^{-5}
β_I	(day ⁻¹)	0.0494	0.2671
β_H	(day ⁻¹)	0.0020	0.0107
β_D	(day ⁻¹)	0.0494	0.2671
δ	(day ⁻¹)	0.0476	0.5000
θ	(day ⁻¹)	0.5000	1.0000
γ	(day ⁻¹)	0.2000	0.5000
λ	(day ⁻¹)	0.0328	0.1272
α	(day ⁻¹)	0.0148	0.1050

We note that, because of the complexity of the nonlinear function $R_0 : (0, +\infty)^9 \times [0, +\infty) \rightarrow \mathbb{R}$, performing an analytical study of its gradient is quite complicated. Thus, we decided to use a numerical approach. Furthermore, for the sake of simplicity, we decided to exclude from this study the possible relationships between parameters (e.g., α and λ are related). To do so, we apply the following algorithm which is described for a general function with N_{param} parameters:

Step 1 Let $N_{\text{param}} \in \mathbb{N}$ be the number of parameters (here, $N_{\text{param}} = 10$ for the function R_0 given in (4.1)). We set N_{scen} and N_{points} , the number of random scenarios and the number of points inside the interval of values of parameters, respectively.

Step 2 **For** $s = 1, 2, \dots, N_{\text{scen}}$,

Step 2.1 We randomly generate a set of parameters, denoted by $P_s = (P_{s,1}, \dots, P_{s,N_{\text{param}}})$, considering a uniform distribution in the interval of values reported in Table 2. We denote by $\underline{P}_{s,p}$ and $\overline{P}_{s,p}$ the minimum and maximum value of parameter $P_{s,p}$, with $p = 1, \dots, N_{\text{param}}$, respectively.

Step 2.2 We compute $\bar{R}_{s,0} = R_0(P_s)$.

Step 2.3 **For** $p = 1, \dots, N_{\text{param}}$,

Step 2.3.1 **For** $k = 1, \dots, N_{\text{points}}$,

Step 2.3.1.1 We set $P_{s,p,k} = \underline{P}_{s,p} \times (1 - \frac{k-1}{N_{\text{points}}-1}) + \overline{P}_{s,p} \times (\frac{k-1}{N_{\text{points}}-1})$.

Step 2.3.1.2 We set $P = P_s$ and replace its p^{th} component $P_{s,p}$ by $P_{s,p,k}$.

Step 2.3.1.3 We compute $\tilde{R}_{s,p,k,0} = R_0(P)$.

Step 2.3.1.4 We compute the relative proportion error between $\tilde{R}_{s,p,k,0}$ and $\bar{R}_{s,0}$ as

$$\text{Err}(s, p, k) = \frac{|\tilde{R}_{s,p,k,0} - \bar{R}_{s,0}|}{\bar{R}_{s,0}}.$$

End For

Step 2.3.2 Considering the values $\tilde{R}_{s,p,k,0}$, we compute $\tilde{\text{Cr}}(s, p)$, the Pearson correlation coefficient (see, e.g., [5]) between vectors

$$(\tilde{R}_{s,p,1,0}, \dots, \tilde{R}_{s,p,N_{\text{points}},0}) \text{ and } (P_{s,p,1}, \dots, P_{s,p,N_{\text{points}}}).$$

End For

End For

Step 3 **For** $p = 1, \dots, N_{\text{param}}$ and $k = 1, \dots, N_{\text{points}}$, we compute the mean relative error given by

$$\overline{\text{Err}}(p, k) = \frac{1}{N_{\text{scen}}} \sum_{s=1}^{N_{\text{scen}}} \text{Err}(s, p, k).$$

End For

For $p = 1, \dots, N_{\text{param}}$, we compute the mean and maximum values of

$$\{\overline{\text{Err}}(p, k)\}_{k=1}^{N_{\text{points}}}.$$

End For

Step 4 **For** $p = 1, \dots, N_{\text{param}}$, compute the mean correlation coefficient of the value of R_0 with respect to the p -th parameter, given by

$$\overline{\text{Cr}}(p) = \frac{1}{N_{\text{scen}}} \sum_{s=1}^{N_{\text{scen}}} \tilde{\text{Cr}}(s, p).$$

End For

Here, we have considered $N_{\text{scen}} = 10^6$ and $N_{\text{points}} = 100$. Thus, the number of R_0 evaluations performed with this algorithm is 10^9 and the computation time on a 3.6 Ghz I7 Intel Computer with 32 Gb of RAM is 573 seconds.

The results obtained with the algorithm detailed above, when studying the sensitivity analysis of R_0 with respect to each parameters of system (3.5) and considering data from the 2014-2016 West African EVD epidemic, are reported in Table 3. We observe that parameter τ has a negligible influence on R_0 . Additionally, β_I and γ are the most sensitive parameters with a mean error greater than 20% and reaching errors up to 374% for the worst scenarios. All other parameters have a moderated impact on the basic reproduction ratio with a mean error lower than 8%, but may produce differences up to 162% for extreme variation cases. Regarding the Pearson correlation coefficient, we note that increasing the values of λ and δ should increases the value of R_0 . Furthermore, R_0 exhibits a linear increasing dependency regarding β_I , β_H or β_D that is why the corresponding Pearson correlation coefficient is 1; furthermore, in this case, computing the partial derivatives of R_0 with respect to those parameters is trivial. On the other hand, increasing all other parameters should decreases the value of R_0 .

The values of the basic reproduction ratios obtained with the algorithm described above were included in the interval $[0.0957, 1.7424]$, with a mean value of 0.5833. Those results show that, for the considered range of parameters, there exist scenarios for which the EVD epidemic may remain endemic in the considered population and, thus, the application of control measure should be applied to contain the disease spread.

4.2. Disease evolution between 2 countries. We now focus on the case of system (3.14)–(3.15), with Country 1 potentially sending infected people to Country 2.

To study some representative numerical examples, we consider two set of parameters, denoted by Set 1 and Set 2, detailed in Table 4, corresponding to basic reproduction ratios of 0.3491 and 1.3910, respectively. Furthermore, we assume

TABLE 3. Mean and maximum values of the relative error $\overline{\text{Err}}$ obtained with the algorithm in Section 4.1, when studying the sensitivity analysis of R_0 with respect to each parameters of system (3.5) and considering data from the 2014-2016 West African EVD epidemic. We also report in the last column the value of $\overline{\text{Cr}}$, the mean Pearson correlation coefficient of the value of R_0 with respect to each parameter.

Parameter	Unit	Mean $\overline{\text{Err}}$	Maximum $\overline{\text{Err}}$	$\overline{\text{Cr}}$
μ	(day ⁻¹)	3.5	42	-0.99
τ	(% day ⁻¹)	10 ⁻³	0.03	-0.99
β_I	(day ⁻¹ person ⁻¹)	40	387	+1.00
β_H	(day ⁻¹ person ⁻¹)	4.4	135	+1.00
β_D	(day ⁻¹ person ⁻¹)	7.7	139	+1.00
δ	(day ⁻¹)	5.8	41	+0.86
θ	(day ⁻¹)	3.7	56	-0.98
γ	(day ⁻¹)	21.3	132	-0.97
λ	(day ⁻¹)	4.7	162	+0.96
α	(day ⁻¹)	6.0	121	-0.95

that the population sizes are $N_1 = 2 \times 10^7$ and $N_2 = 10^7$ in Country 1 and Country 2, respectively (corresponding to countries of approximately the size of Sierra Leone and Guinea). The initial conditions are set to $S_1(0) = 0.999$ (equivalent to 1.998×10^7 people in this particular case), $E_1(0) = 0.001$ (equivalent to 20000 people in this particular case), $S_2(0) = 1$ (equivalent to 10^7 people in this particular case) and all other ratios set to 0. Additionally, $\epsilon = 1/N_1$ to consider emigration flow from Country 1 to Country 2 only in the case that it exists at least one infected individual in Country 1. The model is discretized by considering the explicit Euler scheme with a step size of 1 hour (in previous numerical experiments, this scheme and step size have given a good ratio between precision and computational time, see [23]). The simulation is stopped after a maximum number of 3650 days; or if the change in state S from one iteration to other is lower than 10^{-9} for both countries; or if the proportion of contaminated people (e.g., people either in the state E , I , H or D) in each country is lower than the inverse of the population size.

Taking into account those parameters and numerical methods, we perform the following four experiments:

- **Country 1 with Set 1 and Country 2 with Set 1 (Exp11):** The proportion of contaminated people in both countries is presented in Figure 6. In this case, this proportion is decreasing in Country 1. In Country 2, the maximum ratio of contaminated people is 1.3×10^{-7} (equivalent to 2 people) and is reached after 8.9 days. The initial outbreak in Country 2 is due to the transportation of infected people from Country 1 occurring during the first 77.5 days of the simulation. The simulation stops after 102.7 days because of the low proportion of contaminated people in both countries.
- **Country 1 with Set 1 and Country 2 with Set 2 (Exp12):** The evolution of the proportions of affected and healthy (i.e., people either in

TABLE 4. Values of the parameters in Set 1 and Set 2 used in during the experiments presented in Section 4.2. The basic reproduction ratio (R_0) generated by those values is also reported.

Parameter	Unit	Set 1	Set 2
μ	(day ⁻¹)	0.0197	0.0120
τ	(%day ⁻¹)	2×10^{-5}	2.4×10^{-5}
β_I	(day ⁻¹)	0.1147	0.2671
β_H	(day ⁻¹)	0.0046	0.0107
β_D	(day ⁻¹)	0.1147	0.2671
δ	(day ⁻¹)	0.3643	0.0476
θ	(day ⁻¹)	0.8500	0.5000
γ	(day ⁻¹)	0.4100	0.2000
λ	(day ⁻¹)	0.0564	0.1272
α	(day ⁻¹)	0.0693	0.0148
R_0		1.3910	0.3491

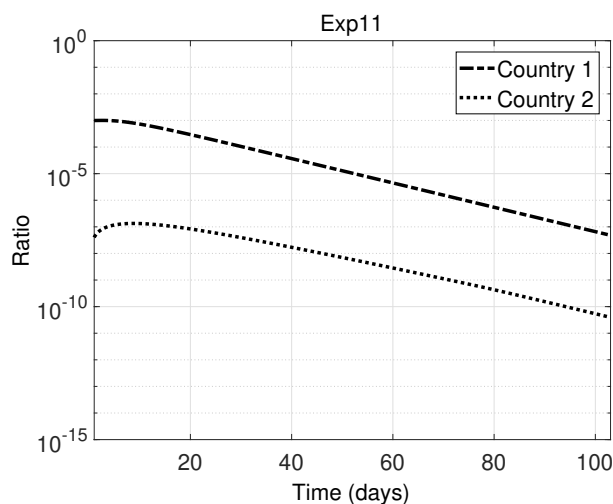

FIGURE 6. Evolution (starting from day 2) of the proportion (in logarithmic scale) of contaminated people in Countries 1 and 2 simulated for the experiment Exp11 in Section 4.2.

the state S or R) people are depicted in Figure 7. We can see in Figure 7 that the ratio of affected people decreases in Country 1. On the opposite, in Country 2 the epidemic starts due to the movement of infected people from Country 1 during 77.5 days and, then, reaches an endemic equilibrium with 23% of affected people. The simulation stops after 1238 because of the stabilization of the numerical solutions. We note that, at the end of the simulation, the final value of (E_2, \dots, R_2) is numerically close to the value of $P_{e,2}$ reported in Theorem 3.7.

- **Country 1 with Set 2 and Country 2 with Set 1 (Exp21):** The evolution of the proportions of affected and healthy people are shown in

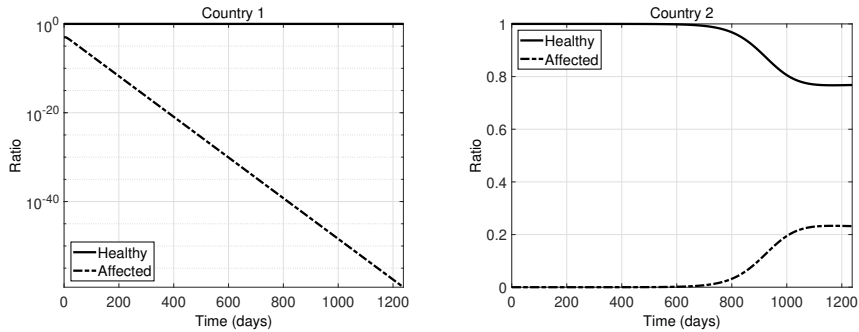

FIGURE 7. Evolution of the proportions of affected and healthy people in Countries 1 (in logarithmic scale) and 2 simulated for experiment Exp1 in Section 4.2.

Figure 8. We can see that the epidemic reaches an endemic equilibrium of 23% of affected people in Country 1. For Country 2, due to the continuous movement of infected people coming from Country 1, the epidemic starts and remains endemic with an equilibrium of $10^{-4}\%$ of affected people in the population. The simulation stops after 1149 days due to the stabilization of the numerical solutions. We note that, as remarked in Theorem 3.7, despite the fact that the basic reproduction ratio of country 2 is lower than 1, the emigration of people from Country 1 does not allow Country 2 to approach a disease free state. Again, we note that, the final value of (E_1, \dots, R_1) is numerically close to the value of $P_{e,1}$ reported in Theorem 3.7.

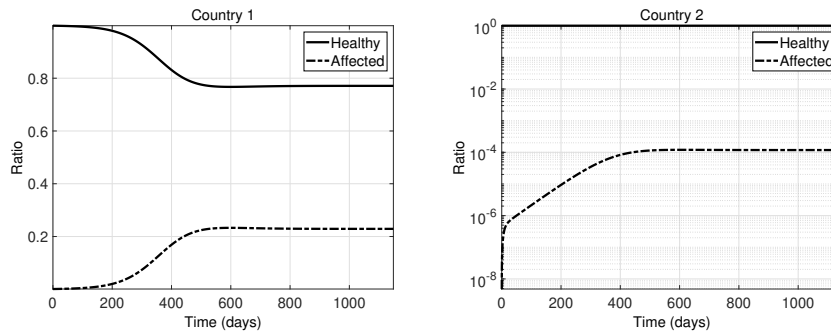

FIGURE 8. Evolution of the proportions of affected and healthy people in Countries 1 and 2 simulated for experiment Exp21 in Section 4.2. In country 2, the evolution is shown from day 2.

- Country 1 with Set 2 and Country 2 with Set 2 (Exp22):** In Figure 9, we report the proportions of affected people in both countries. Endemic states of 23.28% and 23.36% of affected people are reached in Countries 1 and 2, respectively. The epidemic in Country 2 suffers a delay, regarding Country 1, because of the time required to move infected people from Country 1 to Country 2. The simulation stop after 1436 days because

of the stabilization of the numerical solutions. We observe that the final value of (E_1, \dots, R_1) and (E_2, \dots, R_2) are numerically close to the value of $P_{e,1}$ and $P_{e,2}$ reported in Theorem 3.7.

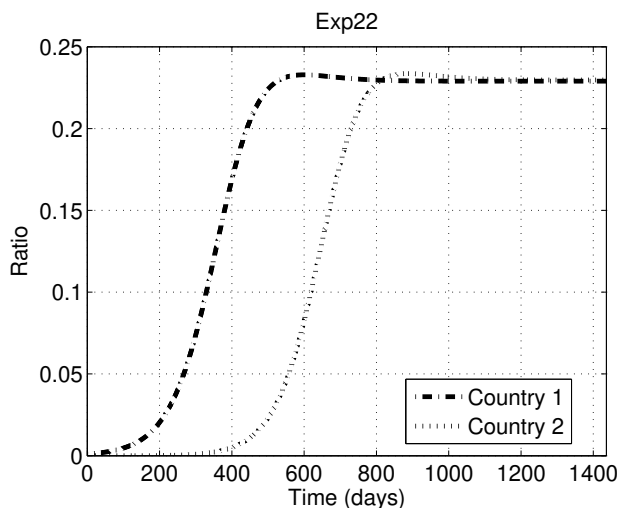

FIGURE 9. Evolution of the proportions of affected people in Countries 1 and 2 simulated for experiment Exp22 in Section 4.2.

We note that all values reported previously are obtained numerically and correspond to approximations of the results detailed in Theorem 3.7. Furthermore, we point out the fact that, when $R_{0,i} > 1$ in country $i \in \{1, 2\}$, we have obtained in this country the numerical convergence of the solution to the endemic equilibrium point reported in Theorem 3.7. This seems to indicate that if $R_{0,i} > 1$, although this result has not been proven theoretically and was only illustrated numerically with particular sets of parameters, this endemic equilibrium point is asymptotically stable.

5. DISCUSSION AND CONCLUSIONS

In this article, we performed an analysis of the equilibrium states of simplified versions of the Be-CoDiS model proposed in [23]. This model aims to study the spread of human diseases between countries.

In Section 3.1, we have estimated a basic reproduction ratio (denoted by R_0) of a version of the model for one country. In particular, we have obtained in Theorem 3.3 an analytical expression of R_0 according to the model parameters. Additionally we have proven that if $R_0 \leq 1$, then the disease free equilibrium is globally and asymptotically stable which is a desirable biological situation because the epidemic will disappear. When $R_0 > 1$, we show that the disease free equilibrium is unstable. This implies that the epidemic will not disappear in the considered population.

Then, starting from this R_0 expression and data from the 2014-16 West African Ebola epidemic, we have performed a sensitivity analysis of the basic reproduction ratio regarding the model parameters. We point out that due to biological reasons, one generally does not have control on parameters μ (the mortality rate) and δ

(transition from E to I). Taking into account this observation, due to the control measures applied by the authorities in order to eradicate the EVD spread (i.e., Isolation, Quarantine, Tracing and Increase of sanitary resources, see [38, 43, 15]), other model parameters can be regulated according to the technical limitations of those control measures. In particular, this sensitivity analysis seems to indicate that decreasing the time of detection of infectious people ($1/\gamma$, the inverse of the transition rate from I to H) and the contact rate with infectious people (β_I) are the most efficient way to reduce the epidemic evolution. During the 2014-16 EVD epidemic, both variables were controlled, for instance, by monitoring the population in areas of EVD risk with health-care workers, by performing information campaigns about the disease and by isolating suspicious cases [10, 7, 42]. For example, considering the case of Guinea, it was estimated that β_I and γ were reduced by the control measures, from 0.1944 and 0.2000, in December 2013, to 0.0871 and 0.3333, in October 2015, respectively [23]. Additionally, controlling contact with hospitalized people (β_H) and dead body (β_D), should have an impact on the EVD magnitude, although lower than reducing β_I and $1/\gamma$. In particular, it was observed that, during the first months of this EVD epidemic, around 20% of the infections were due to contacts with dead bodies [42, 39]. Additionally, the reported number of health workers infected due to contacts with hospitalized people was around 815 in May 2015, which correspond to 4% of the total number of EVD cases [40]. For these variables, control measures, such as the increase of sanitary conditions in hospitals and the supervision of funerals, allowed to reduce those risk factors. It was estimated that, those contact rates were both reduced by two from the beginning to the end of the epidemic [23]. The increase of sanitary resources in hospitals also allowed to increase the value of α (transition from H to R), for instance, in Guinea from 0.0847 to 0.1250 [23]. Regarding θ and λ , both parameters were controlled by reducing the duration of the funerals and the death rate (e.g., by improving the healthcare system). In particular, for Guinea, θ passes from 0.5 to 1 and λ from 0.2381 to 0.1707 [23]. We note that the classification of the importance of the model parameters in EVD control proposed here is consistent with the response plan proposed by the international community to fight the EDV outbreaks [41]. All those results seem to validate the interest of using system (3.5) and its R_0 value to identify the most important factors of an epidemic evolution.

Next, in Section 3.2, we have described the behavior of the epidemic evolution when two countries are connected by an emigration flow. From Theorem 3.7, we conclude that when $R_{0,1} \leq 1$ (where $R_{0,1}$ is computed with formula (3.16)) in Country 1, the evolution of the disease in Country 2 only depends on the value of $R_{0,2}$. More precisely, if $R_{0,2} \leq 1$, the epidemic disappears in Country 2, whereas if $R_{0,2} > 1$ it may become endemic in Country 2. On the opposite, when $R_{0,1} > 1$, under some reasonable assumptions, the epidemic may remain active in Country 2, even if $R_{0,2} \leq 1$. This behavior was illustrated in Section 4.2 by performing four particular numerical experiments with several sets of parameters estimated from the 2014-16 EVD epidemic. The numerical results shown here are consistent with those found theoretically. Additionally, those numerical results seem to indicate that if $R_{0,i} > 1$ for Country $i \in \{1, 2\}$, the epidemic in this country should converge to the endemic equilibrium point $P_{e,i}$ defined in Theorem 3.7 (property which is not proven theoretically). Those outcomes tend to show the necessity to control the emigration

flows from countries with serious epidemic scenarios. This recommendation was also proposed in the literature for the case of the 2014-16 EVD epidemic [4].

Acknowledgments. This work was carried out with financial support from the Spanish “Ministry of Economy and Competitiveness” under projects MTM2015-64865-P, the MOMAT UCM research Group (Ref. 910480), and the “Institut de Recherche et de Développement” through projects UMI 2019-IRD and UMMUSCO-UGB.

REFERENCES

- [1] M. Anderson; *Population biology of infectious diseases: Part 1*, Nature **280** (1979), 361–367.
- [2] N. P. Bhatia, G. P. Szegő; *Dynamical systems: Stability theory and applications*, Lecture Notes in Mathematics, No. 35, Springer Verlag, Berlin, 1967.
- [3] D. Bichara, A. Iggidr, G. Sallet; *Global analysis of multi-strains sis, sir and msir epidemic models*, Journal of Applied Mathematics and Computing **44** (2014), no. 1, 273–292.
- [4] I.I . Bogoch, M. I. Creatore, M. S. Cetron, J.S . Brownstein, N. Pesik, J. Miniota, T. Tam, W. Hu, A. Nicolucci, S. Ahmed, J. W. Yoon, I. Berry, S.I. Hay, A. Anema, A. J. Tatem, D. MacFadden, M. German, K. Khan; *Assessment of the potential for international dissemination of ebola virus via commercial air travel during the 2014 west african outbreak*, The Lancet **9962** (2016), 29–35.
- [5] S. Boslaugh; *Statistics in a nutshell, 2nd edition*, O’Reilly Media, Incorporated, 2012.
- [6] F. Brauer, C. Castillo-Chávez; *Mathematical models in population biology and epidemiology*, Texts in applied mathematics, Springer, 2001.
- [7] C. D. C.; *Ebola disease*, Centers for Disease Control (2014).
- [8] T. Chen, Z. Sun, B. Wu; *Stability of multi-group models with cross-dispersal based on graph theory*, Applied Mathematical Modelling **47** (2017), 745 – 754.
- [9] G. Chowell, F. Abdirizak, S. Lee, J. Lee, E. Jung, H. Nishiura, C. Viboud; *Transmission characteristics of mers and sars in the healthcare setting: a comparative study*, BMC Medicine **13** (2015), no. 1, 1–12.
- [10] G. Chowell, H. Nishiura; *Transmission dynamics and control of ebola virus disease (evd): a review*, BMC Medecine **12** (2014), no. 196.
- [11] D. L. DeAngelis, L. J. Gross; *Individual-based models and approaches in ecology: Populations, communities, and ecosystems*, Chapman & Hall, 1992.
- [12] O. Diekmann, H. Heesterbeek, T. Britton; *Mathematical tools for understanding infectious disease dynamics*; Princeton Series in Theoretical and Computational Biology, Princeton University Press, 2012.
- [13] O. Diekmann, J. A. P. Heesterbeek, J. A. J. Metz; *On the definition and the computation of the basic reproduction ratio R_0 in models for infectious diseases in heterogeneous populations*, Journal of Mathematical Biology **28** (1990), no. 4, 365–382.
- [14] R. T. D. Emond, B. Evans, E. T. W. Bowen, G. Lloyd; *A case of ebola virus infection*, Br Med J. **2** (1977), 541–544.
- [15] D. Fisman, E. Khoo, A. Tuite; *Early epidemic dynamics of the west african 2014 ebola outbreak: Estimates derived with a simple two-parameter model*, PLOS Currents Outbreaks **1** (2014).
- [16] M. F. C. Gomes, A. Pastore y Piontti, L. Rossi, D. Chao, I. Longini, M. E. Halloran, A. Vespignani; *Assessing the international spreading risk associated with the 2014 west african ebola outbreak*, PLOS Currents Outbreaks **1** (2014).
- [17] Y. He, S. Gao, D. Xie; *An sir epidemic model with time-varying pulse control schemes and saturated infectious force*, Applied Mathematical Modelling **37** (2013), no. 16, 8131 – 8140.
- [18] J. A. P. Heesterbeek, K. Dietz; *The concept of ro in epidemic theory*, Statistica Neerlandica **50** (1996), no. 1, 89–110.
- [19] N. Hernandez-Ceron, Z. Feng, C. Castillo-Chavez, *Discrete epidemic models with arbitrary stage distributions and applications to disease control*, Bulletin of Mathematical Biology **75** (2013), no. 10, 1716–1746 (English).
- [20] H. W. Hethcote; *The mathematics of infectious diseases*, SIAM Review **42** (2000), no. 4, 599–653.

- [21] B. Ivorra, M. R. Ferrández, M. Vela-Pérez, A. M. Ramos; *Mathematical modeling of the spread of the coronavirus disease 2019 (covid-19) taking into account the undetected infections. the case of china*, Communications in Nonlinear Science and Numerical Simulation **88** (2020), 105303.
- [22] B. Ivorra, B. Martínez-López, J. M. Sánchez-Vizcaíno, A. M. Ramos; *Mathematical formulation and validation of the Be-FAST model for classical swine fever virus spread between and within farms*, Annals of Operations Research **219** (2014), no. 1, 25–47 (English).
- [23] B. Ivorra, D. Ngom, A. M. Ramos; *Be-codis: A mathematical model to predict the risk of human diseases spread between countries—validation and application to the 2014–2015 ebola virus disease epidemic*, Bulletin of Mathematical Biology **77** (2015), no. 9, 1668–1704.
- [24] B. Ivorra, A. M. Ramos; *Application of the be-codis mathematical model to forecast the international spread of the 2019-20 wuhan coronavirus outbreak*, Technical report from ResearchGate. (2020), 1–13.
- [25] E. Kokomo, Y. Emvudu; *Mathematical analysis and numerical simulation of an age-structured model of cholera with vaccination and demographic movements*, Nonlinear Analysis: Real World Applications **45** (2019), 142–156.
- [26] J. Legrand, R. F. Grais, P. Y. Boelle, A. J. Valleron, A. Flahault; *Understanding the dynamics of ebola epidemics.*, Med. Hypotheses. **135** (2007), no. 4, 610–621.
- [27] P. E. Lekone, B. F. Finkenstädt; *Statistical inference in a stochastic epidemic seir model with control intervention: Ebola as a case study*, Biometrics **62** (2006), no. 4, 1170–1177.
- [28] B. Martínez-López, B. Ivorra, E. Fernández-Carrión, A. M. Perez, A. Medel-Herrero, F. Sánchez-Vizcaíno, C. Gortázar, A.M. Ramos, J. M. Sánchez-Vizcaíno; *A multi-analysis approach for space-time and economic evaluation of risks related with livestock diseases: The example of fmd in Peru*, Preventive Veterinary Medicine **114** (2014), no. 1, 47–63.
- [29] B. Martínez-López, B. Ivorra, D. Ngom, A. M. Ramos, J. M. Sánchez-Vizcaíno; *A novel spatial and stochastic model to evaluate the within and between farm transmission of classical swine fever virus. II. Validation of the model*, Veterinary Microbiology **155** (2012), no. 1, 21–32.
- [30] B. Martínez-López, B. Ivorra, A. M. Ramos, E. Fernández-Carrión, T. Alexandrov, J. M. Sánchez-Vizcaíno; *Evaluation of the risk of classical swine fever spread from backyard pigs to other domestic pigs by using the spatial stochastic disease spread model Be-FAST: The example of Bulgaria*, Veterinary Microbiology **165** (2013), no. 1–2, 79–85.
- [31] B. Martínez-López, B. Ivorra, A. M. Ramos, J. M. Sánchez-Vizcaíno; *A novel spatial and stochastic model to evaluate the within- and between-farm transmission of classical swine fever virus. I. General concepts and description of the model*, Veterinary Microbiology **147** (2011), no. 3–4, 300–309.
- [32] M. I. Meltzer, C. Y. Atkins, S. Santibanez, B. Knust, B. W. Petersen, E. D. Ervin, S. T. Nichol, I. K. Damon, M. L. Washington; *Estimating the future number of cases in the ebola epidemic - Liberia and Sierra Leone, 2014–2015*, Centers for Disease Control. MMWR / Early Release **63** (2014).
- [33] C. J. Peters, J. W. Peters; *An introduction to ebola: The virus and the disease*, Journal of Infectious Diseases **179** (1999), no. Supplement 1, ix–xvi.
- [34] Z. Shuai, P. Van den Driessche; *Global stability of infectious disease models using lyapunov functions*, SIAM Journal on Applied Mathematics **73** (2013), no. 4, 1513–1532.
- [35] H. R. Thieme; *Mathematics in population biology*, Mathematical Biology Series, Princeton University Press, 2003.
- [36] P. van den Driessche, J. Watmoughm; *Reproduction numbers and sub-threshold endemic equilibria for compartmental models of disease transmission*, Mathematical Biosciences **180** (2002), no. 1-2, 29–48.
- [37] P. van den Driessche, J. Watmough; *Further notes on the basic reproduction number*, pp. 159–178, Springer Berlin Heidelberg, Berlin, Heidelberg, 2008.
- [38] W. H. O.; *Fact sheet n°103: Ebola virus disease*, World Health Organization (2014).
- [39] W. H. O.; *New who safe and dignified burial protocol - key to reducing ebola transmission*, World Health Organization (2014).
- [40] W. H. O.; *Health worker ebola infections in guinea, liberia and sierra leone*, World Health Organization (2015).
- [41] W. H. O.; *Who strategic response plan 2015: West africa ebola outbreak*, World Health Organization (2015), ISBN: 9789241508698.

- [42] W. H. O.; *Ebola publications: Case management, infection prevention and control*, World Health Organization (2016).
- [43] W. H. O.; *Global alert and response: Ebola virus disease*, World Health Organization (2016).
- [44] W. H. O. Response Team; *Ebola virus disease in west africa - the first 9 months of the epidemic and forward projections.*, New England Journal of Medicine **371** (2014), 1481–1495.
- [45] D. Yan and H. Cao.; *The global dynamics for an age-structured tuberculosis transmission model with the exponential progression rate*, Applied Mathematical Modelling **75** (2019), 769 – 786.
- [46] L. Zhu, G. Guan, Y. Li; *Nonlinear dynamical analysis and control strategies of a network-based sis epidemic model with time delay*, Applied Mathematical Modelling **70** (2019), 512 – 531.

BENJAMIN IVORRA

INSTITUTO DE MATEMÁTICA INTERDISCIPLINAR (IMI), DEPARTMENT OF APPLIED MATHEMATICS AND MATHEMATICAL ANALYSIS, AND MOMAT RESEARCH GROUP, COMPLUTENSE UNIVERSITY OF MADRID, PLAZA DE CIENCIAS, 3, 28040, MADRID, SPAIN

Email address: ivorra@ucm.es

DIÈNE NGOM

DÉPARTEMENT DE MATHÉMATIQUES, UNIVERSITÉ ASSANE SECK DE ZIGUINCHOR, UMI 2019-IRD & UMMUSCO-UGB, BP 5233, ZIGUINCHOR, SENEGAL

Email address: dngom@univ-zig.sn

ANGEL M. RAMOS

INSTITUTO DE MATEMÁTICA INTERDISCIPLINAR (IMI), DEPARTMENT OF APPLIED MATHEMATICS AND MATHEMATICAL ANALYSIS, AND MOMAT RESEARCH GROUP, COMPLUTENSE UNIVERSITY OF MADRID, PLAZA DE CIENCIAS, 3, 28040, MADRID, SPAIN

Email address: angel@mat.ucm.es